

DATE PROJECT

COMMENTS



Manufactured in the USA Vertically Integrated Manufacturing Acoustic Baffle

ACOUSTIC BLADE

PENDANT / SURFACE UNLIT BAFFLE

FEATURES

The Acoustic Blade baffle has been designed to complement any space with a clean design style and visual appeal that improves acoustics and reduces unwanted noise.

SOUND DAMPENING RATING

Sound Absorption: Average NRC 0.85 (Subject to mounting conditions)

MATERIAL

100% polyester fiber acoustic felt.

ECO-FRIENDLY

60% recycled PET materials, 40% new material, non-toxic, non-allergenic, non-irritant, no coatings or sprays which degrade over time.

FIRE RATING

ASTM E84 Class A Fire Spread rating is permanently achieved by infusing 40% new material into the panel.

MOUNTING: PENDANT

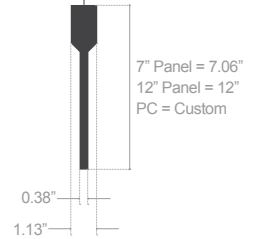

SAMPLE PART NUMBER: BLD-08-T1-08-P12-CB96

ORDERING

SERIES	LENGTH ¹	MOUNTING	ACOUSTIC BAFFLE COLOR			PANEL HEIGHT	SUSPENSION
BLD							
02	2 FT	T1 1" Grid	Colors	Textures	P07 7" Tall Panel	BLANK = 48" CABLE	
04	4 FT	T9 9/16" Grid	01 Blueberry	13 Wine	50 Dark Walnut	P12 12" Tall Panel	CB96 96" Cable
06	6 FT	SC Screw Slot	02 Moss	15 Evergreen	52 Ash	PC² Custom	CB144 144" Cable
08	8 FT	HC Hard Ceiling	03 Marble	18 Granite	53 Honey	BC	Black Canopy
		JB Junction Box	04 Graphite	24 Snow	54 Plywood		
			05 Blue Sky	25 Cherry	61 Fresh Plywood		
			06 Orange	26 Grape	62 Italian Walnut		
			07 Sand	33 Slate	63 Main Street Elm		
			09 Onyx	39 Earth	64 Planche Oak		
			11 Lemon	43 Ivory	65 Vista Walnut		
			12 Avocado	46 Green Apple	66 Weathered Plywood		

ORDERING NOTES

¹ Individual fixtures only, 2' minimum length, 8' maximum length

² Contact Lumato for available options and additional lead-times (quotes@lumato.com)

ACOUSTIC BLADE

PENDANT / SURFACE UNLIT BAFFLE



Manufactured in the USA



Vertically Integrated Manufacturing



Acoustic Baffle

ACOUSTIC BAFFLE OPTIONS

COLORS



01 Blueberry



02 Moss

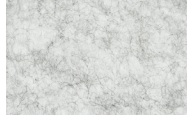

03 Marble



04 Graphite



05 Blue Sky



06 Orange



07 Sand



09 Onyx



11 Lemon



12 Avocado



13 Wine



15 Evergreen



18 Granite

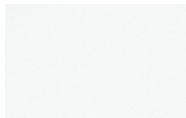

24 Snow



25 Cherry



26 Grape



33 Slate



39 Earth

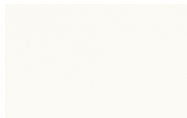

43 Ivory



46 Green Apple

TEXTURES

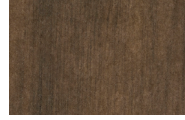

50 Dark Walnut



52 Ash



53 Honey



54 Plywood



61 Fresh Plywood

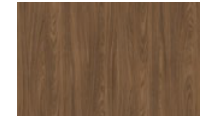

62 Italian Walnut



63 Main Street Elm



64 Planche Oak



65 Vista Walnut

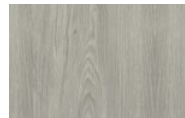

66 Weathered Plywood

COMPLETE SERIES COLLECTION

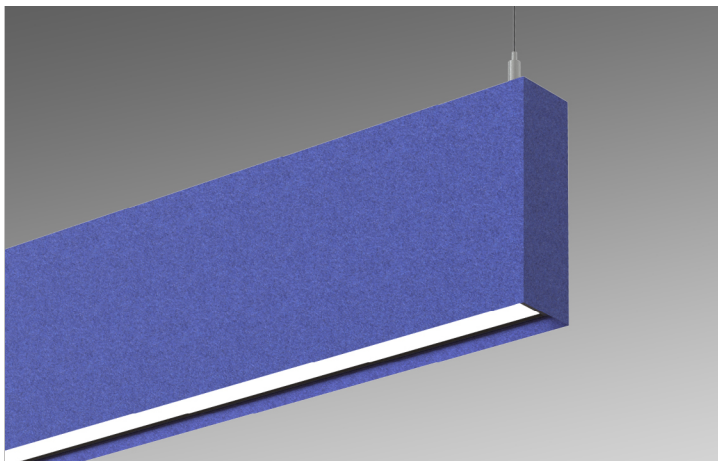

SLĚK ACOUSTIC

Distribution: Direct

Dimensions: 7.00" or 12.00"H x 2.13"W

Mounting: Suspended

Sound Absorption: Average NRC 1.4 (Subject to mounting conditions)

[VIEW SPEC SHEET](#)

Learn more at: [Lumato.com/Project/slek-acoustic](https://www.lumato.com/Project/slek-acoustic)

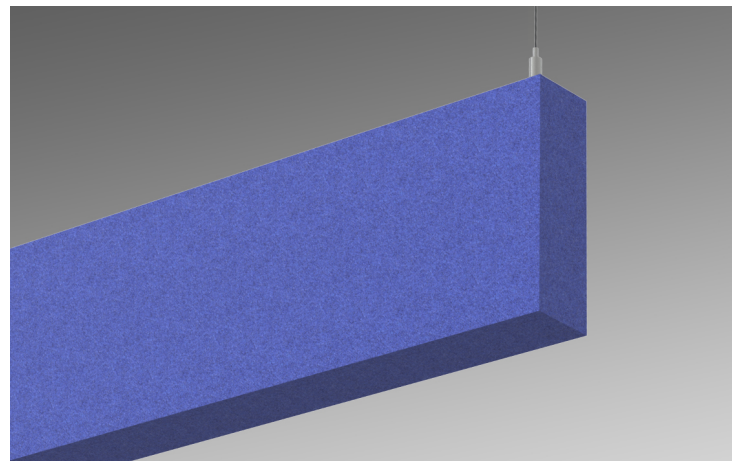

ACOUSTIC UNLIT BOX MINI

Dimensions: 7.00"H x 2.13"W

Mounting: Pendant or Magnetic Surface

Sound Absorption: Average NRC 1.4 (Subject to mounting conditions)

[VIEW SPEC SHEET](#)

Learn more at: [Lumato.com/Project/acoustic-unlit-box-mini](https://www.lumato.com/Project/acoustic-unlit-box-mini)

ACOUSTIC BLADE

PENDANT / SURFACE UNLIT BAFFLE



Manufactured in the USA



Vertically Integrated Manufacturing



Acoustic Baffle

MOUNTING

CABLE MOUNT

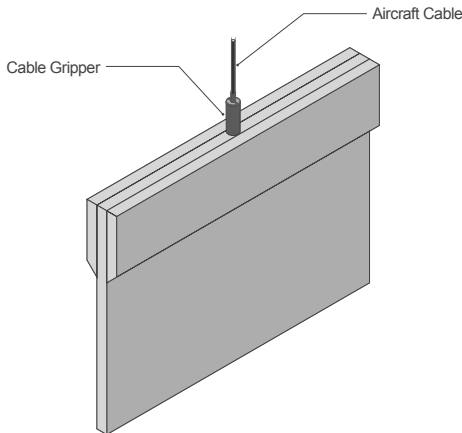

INSTALLATION

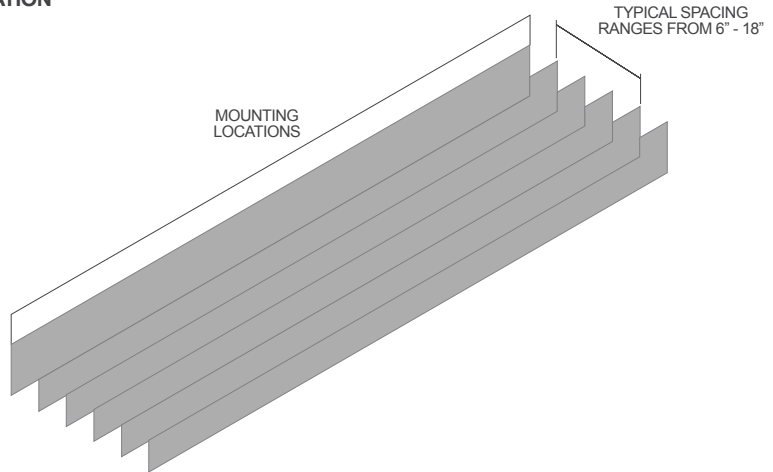

ELEVATION

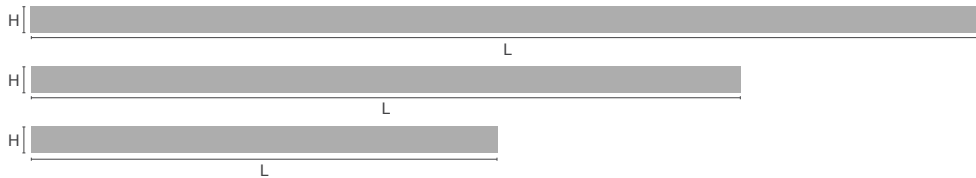

BOX DIMENSIONS

	HEIGHT	LENGTH	WIDTH
4 FT	7" (P07) or 12" (P12)	48"	1.13"
6 FT	7" (P07) or 12" (P12)	72"	1.13"
8 FT	7" (P07) or 12" (P12)	96"	1.13"

SPECIFICATIONS

MECHANICAL

Housing Construction:

The Acoustic Blade baffle is made of 100% polyester fiber acoustic felt

Lengths:

The Acoustic Blade is available in direct 1-foot increments. Individual 2-foot (24"), 3-foot (36"), 4-foot (48"), 5-foot (60"), 6-foot (72"), 7-foot (84"), and 8-foot (96") lengths. Overall lengths with acoustic baffle are +1.0625" greater than the nominal length (i.e. 4' = 49.0625").

Mounting Method/Hardware:

Standard hanging hardware includes 1/16" diameter, galvanized steel aircraft cable with adjustable and lockable nickel-plated cable grippers at the luminaire. The standard hardware includes a 60" aircraft cables to accommodate a 48" mounting distance from the ceiling. Ceiling canopy provided. All suspension hardware is tested and listed to UL1598 requirements for loading/fixture support.

Exterior Finish:

The acoustic baffle is made of 100% polyester fiber felt. Available in the following Colors: Blueberry (01), Moss (02), Marble (03), Graphite (04), Blue Sky (05), Orange (06), Sand (07), Onyx (09), Lemon (11), Avocado (12), Wine (13), Evergreen (15), Granite (18), Snow (24), Cherry (25), Grape (26), Slate (33), Earth (39), Ivory (43), Green Apple (46). Available Textures: Dark Walnut (50), Ash (52), Honey (53), Plywood (54), Fresh Plywood (61), Italian Walnut (62), Main Street Elm (63), Planche Oak (64), Vista Walnut (65), Weathered Plywood (66)

PERFORMANCE

Acoustic:

All raw materials are sustainably sourced from carefully selected vendors within the USA and abroad. All acoustic felt is made from low-VOC, 60% recycled PET polyester felt material. Hardware, fasteners, and frame components are also made from recycled aluminum. Frames are custom ordered in standardized sizes to prevent waste in the supply chain.

All Lumato Acoustic products are free of allergens, irritants, and coatings/sprays that degrade or give off VOC's. All acoustic materials also meet ASTM E84 Class A, Flame Spread 40.

Product Maintenance:

Our acoustic baffles and panels are inherently easy to maintain. They can be wiped down with a damp cloth or vacuumed as needed.

If a stain does appear, warm water and soap can be used to gently blot the area affected.

Acoustic baffles and panels are 100% recyclable at end of life.

GENERAL

Warranty:

Two (2) year limited warranty for the acoustic baffle. Optional accessories are covered by their individual manufacturer warranties.

Acoustic Baffle Fire Rating:

ASTM E84 Class A Fire Spread rating is permanently achieved by infusing 40% new material into the panel. Our manufacturing process never uses sprays or coatings that degrade or lose their rating status.

Manufactured in the USA:

All Lumato Acoustic series products are proudly manufactured and assembled in the USA.

Shipping:

6-Week lead-time for orders up to 1000 linear feet.

Lead-time for orders greater than 1000 linear feet will be determined at time of order.